

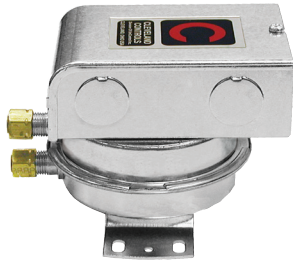

AIR PRESSURE SENSING SWITCHES

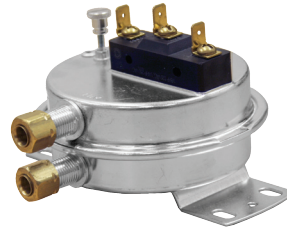

RFS-4001: Field adjustable set point switch with conduit enclosure.



RFS-4100: Open mounted switch with field adjustable set point.

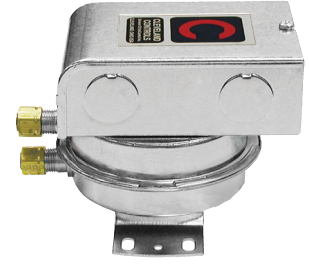

RFS-4300: Factory-calibrated set point switch with conduit enclosure.

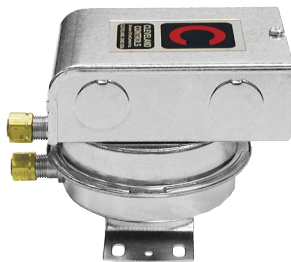

RFS-4002: Non-adjustable set point switch with conduit enclosure.

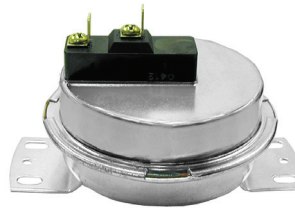

RFS-4200: Open mounted switch with non-adjustable set point.



RFS-4400: Open mounted switch with factory calibrated set point.

APPLICATION

Series RFS-4000 is a line of general purpose proving switches designed for HVAC and Energy Management applications. These switches can be used to sense positive, negative, or differential air pressure.

DESCRIPTION & OPERATION

The plated housing encloses a diaphragm, a snap-acting switch, and an optional calibration spring (in adjustable set point models). The sample line connections located on each side of the diaphragm accept rigid or flexible tubing. Various electrical connections are available. An optional enclosure cover can be provided to protect the operator from accidental contact with the live switch contacts. The enclosure cover has five knockouts for a 1/2" conduit connection.

MOUNTING

Select a mounting location that is free from vibration. The **Series RFS-4000** Air Pressure Sensing Switch must be mounted with the diaphragm in any vertical plane in order to maintain the specified operating set point. Avoid mounting with the sample line connections in the "up" position. Refer to **Figure 1**.

The standard model is surface-mounted via the two round holes (0.14" dia.) or two of the four slots (3/16" wide) on the zinc-plated strap bracket. The mounting holes and slots are 3-7/8" apart. Custom mounting configurations are available.

AIR SAMPLING CONNECTION

Series RFS-4000 switches are equipped with sample line connectors situated on either side of the diaphragm as shown in **Figure 2**. In standard models,* these connections may be either compression fittings suitable for rigid (1/4" OD) aluminum, copper or plastic tubing, or tri-barb connectors suitable for flexible (3/16", 1/4" or 5/16" ID) tubing. Install the sampling probe as close to the center of the airstream as possible. Locate the sampling probe a minimum of 1.5 duct diameters downstream from the air source. Insert the probe as close to the center of the air stream as possible.

Refer to **Figure 2** to identify the high pressure inlet (**H**) and the low pressure inlet (**L**). Select one of the five application options listed below, and connect the sample lines

*Other types of sample line connectors are available by special order. See Specifications.

as recommended.

Positive Pressure Only: Connect the sample line to inlet H; inlet L remains open to the atmosphere.

Negative Pressure Only: Connect the sample line to inlet L; inlet H remains open to the atmosphere.

Two Negative Samples: Connect the higher negative sample to inlet L. Connect the lower negative sample to inlet H.

Two Positive Samples: Connect the higher positive sample to inlet H. Connect the lower positive sample to inlet L.

One Positive and One Negative Sample: Connect the positive sample to inlet H. Connect the negative sample to inlet L.

ELECTRICAL CONNECTIONS

Before pressure is applied to the diaphragm, the switch contacts will be in the normally closed (**NC**) position. Wire control and alarm functions as shown in **Figure 3**.

RANGE

The adjustment range of a standard **Series RFS-4000** Air Switch is 0.15±0.02" wc to 2.0"wc or 0.15±0.02" wc to 5.0"wc.



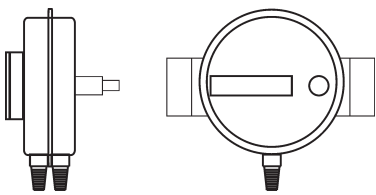

Figure 1

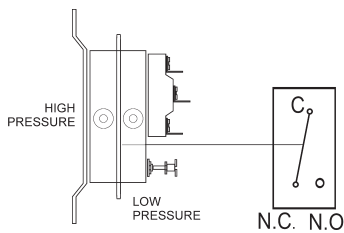
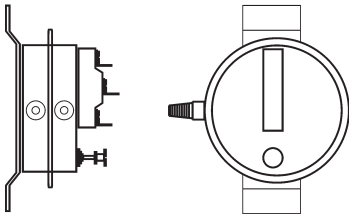
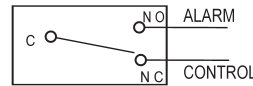

Figure 2

To prove excessive air flow or pressure:



To prove insufficient air flow or pressure:

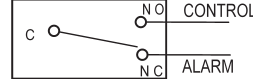
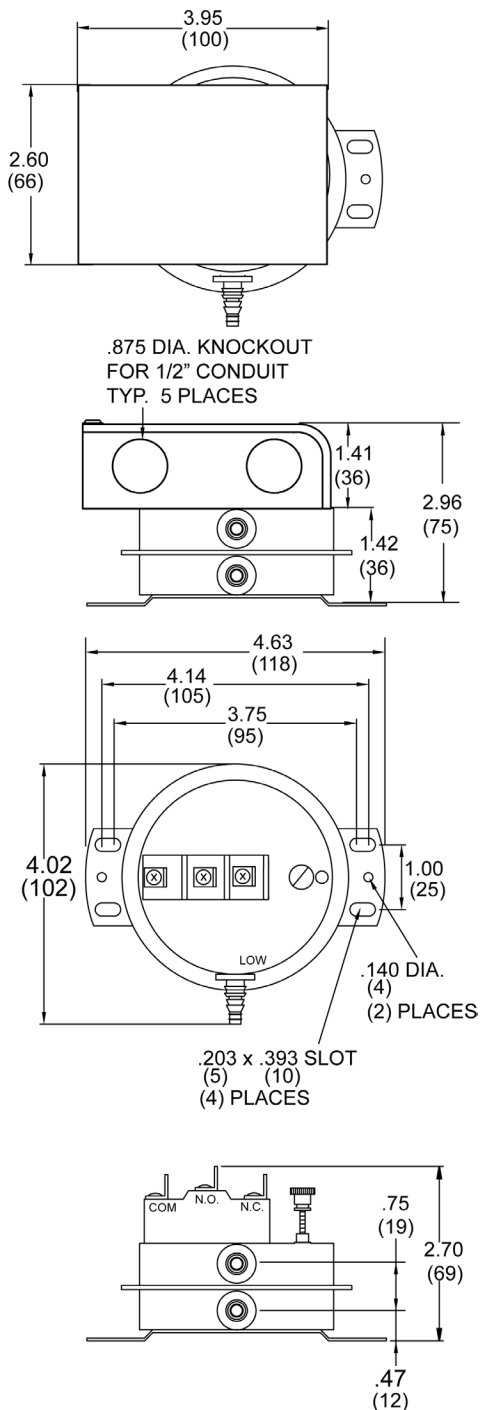
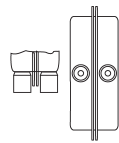

Figure 3



Typical Reference Dimensions in Inches (Millimeters)



1/8" - 27 NPT
female thread.

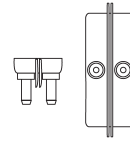

1/4" OD
slip-on fitting.

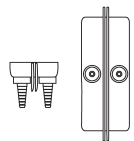

Tri-barb
connectors for
3/16", 1/4" & 5/16" ID
plastic tubing.

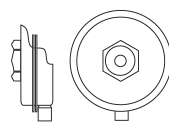

1/4" - 18 NPT
female thread
in combination with
1/8" - 27 NPT
female thread.

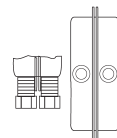

Externally threaded
7/16" 24- UNS 2A or
1/2" 20- UNF 2A
thread with nuts and
self-aligning ferrules.

SPECIFICATIONS

SERIES RFS-4000 AIR PRESSURE SENSING SWITCHES

Mounting Position:

- Mount with the diaphragm in any vertical plane.

Standard Set Point Ranges:

- 0.15 ± 0.02" wc to 2.0" wc.
- 0.15 ± 0.02" wc to 5.0" wc.

Field Adjustable "Operate Ranges":

- 0.17" wc to 2.0" wc.
- 0.17" wc to 5.0" wc.

Field Adjustable "Release Ranges":

- 0.10" wc to 1.8" wc.
- 0.10" wc to 4.7" wc.

Approximate Switch Differentials:

- **For 2.0"wc set point range:** progressive, increasing from 0.05±0.02" wc at minimum set point to approximately 0.2" wc at maximum set point.
- **For 5.0"wc set point range:** progressive, increasing from 0.05±0.02" wc at minimum set point to approximately 0.3" wc at maximum set point.

Measured Media:

- Air or combustion by-products that will not degrade silicone.

Maximum Pressure:

- 1/2 psi (0.03 bar).

Operating Temperature Range:

- -40 to 180 °F (-40.0 to 82.2 °C).

Life:

- 100,000 cycles minimum at 1/2 psi maximum pressure each cycle and at maximum rated electrical load.

Electrical Rating:

- 300 VA pilot duty at 115 to 277 VAC;
- 15 amp noninductive to 277 VAC, 60 Hz.

Contact Arrangement:

- SPST-NO.
- SPST-NC.
- SPDT.

Electrical Connections:

- 1/4", 90° quick-connect spade terminals.
- Screw terminals with cup washers.

Sample Line Connectors:

- Externally threaded 7/16" -24 UNS 2A or 7/16" -20 UNF 2A thread with nuts and self-aligning ferrules.
- 1/8" - 27 NPT female connectors.
- 1/4" - 18 female thread in combination with 1/8" - 27 NPT female connectors.
- 1/4" slip-on connectors.
- Tri-barb connectors for 3/16", 1/4", and 5/16" ID tubing.

Approvals: UL, CUL.

Shipping Weight: < 1 lb.